



PASCO Specialty & Mfg., Inc.

P.O. Box 1667
South Gate, CA 90280
Phone (310) 537-7782
Fax (800) 737-2726

7529 Perryman Court
Curtis Bay, MD 21226
Phone (410) 360-5010
Fax (877) 377-6466

www.pascospecialty.com

TECHNICAL SPECIFICATION SUBMITTAL

Job Name _____ Date _____

Model Specified _____ Quantity _____

Customer/Wholesaler _____

Contractor _____

Architect/Engineer _____

Engineering Specification:

8" CHROME PLATED BRASS SHOWER ARM WITH FLANGE

#11867

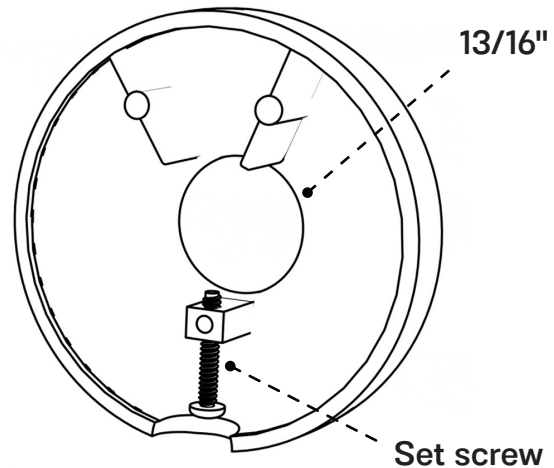
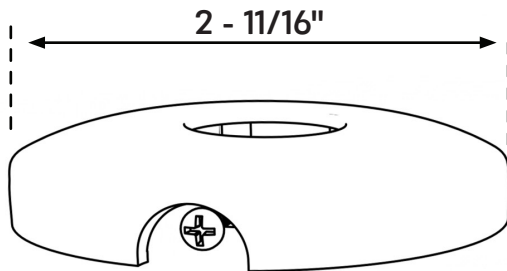
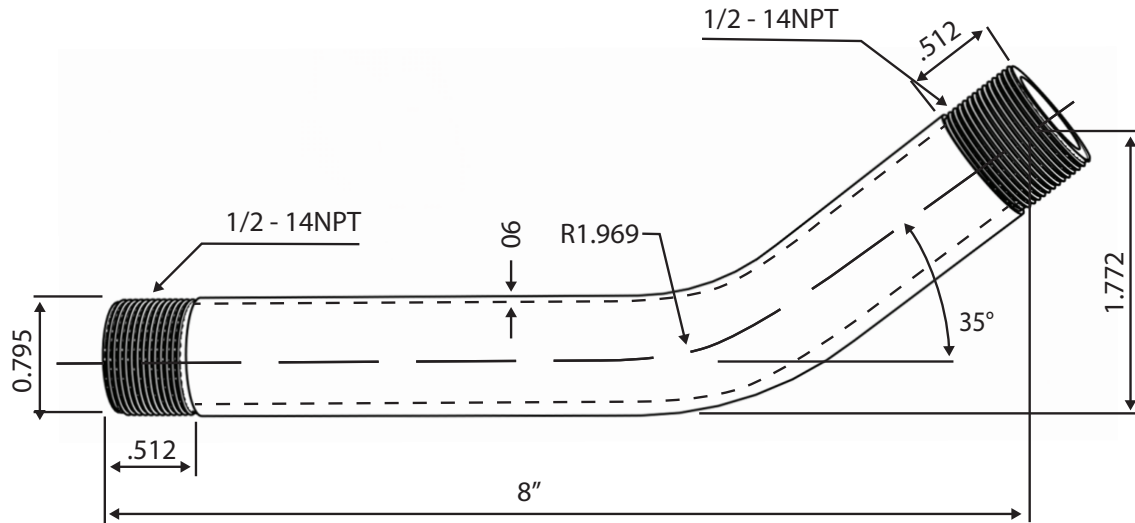

WARNING: Birth Defects, Reproductive Harm, and Cancer. www.p65warnings.ca.gov.