



Generic General Style

PASCO manufactures these Drain Snake Specialties to the exacting standards of the professional plumbing industry. The products pictured on the following pages fit a variety of drain snake cables used in the plumbing trade.

1-1/4" Side Cutter Blades

For 5/16" and 3/8" Cables



PART NUMBER
PS-125

Boring Auger

For 5/16" and 3/8" Cables



PART NUMBER
PS-4

1-1/2" U-Cutter

For 3/8" and 1/2" Cables



PART NUMBER
PS-15

Drop Head Boring Auger

For 5/16" and 3/8" Cables



PART NUMBER
PS-5

Cable Side Cutter Blades

For 3/8", 1/2", 5/8", and 3/4" Cables



PART NUMBER	SIZE
PS-2B	2"
PS-3B	3"
PS-4B	4"

Drop Head Fitting

For 5/16" and 3/8" Cables



PART NUMBER
PS-6

Arrowhead Starting Drill

For 5/16", 3/8", and 1/2" Cables



PART NUMBER
PS-1

Flexible Arrowhead

For 5/16" and 3/8" Cables



PART NUMBER
PS-7

Spearhead Starting Drill

For 5/8" and 3/4" Cables

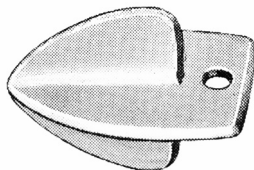

PART NUMBER
PS-3

U-Cutters

For 5/8" and 3/4" Cables



PART NUMBER	SIZE
PS-20	2"
PS-30	3"
PS-40	4"



Generic General Style

PASCO manufactures these Drain Snake Specialties to the exacting standards of the professional plumbing industry. The products pictured on the following pages fit a variety of drain snake cables used in the plumbing trade.

3" Rotary Saw Blades

For 1/2", 5/8", and 3/4" Cables



PART NUMBER
PS-38

Small Corkscrew Retrieving Tool

For 3/8" and 1/2" Cables

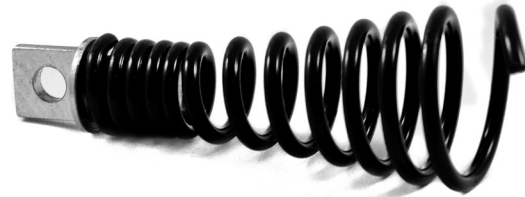

PART NUMBER
PS-10

Cable Gripper



PART NUMBER
PS-25

Drain Snake Tool Adapters

- Made of tempered steel
- Fits 5/16", 3/8" and 1/2" cables

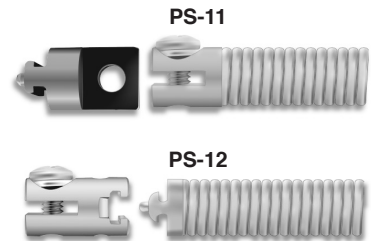

PART NUMBER	Description
PS-23	Drain Snake Tool Adapters
PS-11	Adapts Ridgid Heads to General Cables
PS-12	Adapts General Heads to Ridgid Cables

5 Piece Toolset - 3/8" Cable

- Flexible Arrowhead (PS-7)
- Boring Auger (PS-4)
- Arrowhead Starting Drill (PS-1)
- 1-1/4" Side Cutter Blades (PS-125)
- Drop Head Boring Auger (PS-5)



COMPLETE KIT NUMBER
PS-5P

4 Piece Toolset - 3/8" Cable

- Arrowhead Starting Drill (PS-1)
- Boring Auger (PS-4)
- 1-1/2" U-Cutter (PS-15)
- 2" Cable Side Cutter Blades (PS-2B)



COMPLETE KIT NUMBER
PS-4P



Generic Ridgid Style

PASCO manufactures these Drain Snake Specialties to the exacting standards of the professional plumbing industry. The products pictured on the following pages fit a variety of drain snake cables used in the plumbing trade.

Straight Auger



PART NUMBER	CABLE	LENGTH	CONNECTOR SIZE
PS-990	3/8" & 1/2"	5"	5/8"
PS-850	1/2" & 7/8"	8"	7/8"

Double Tooth Cutter



PART NUMBER	CABLE	PIPE SIZE
PS-510	5/8" & 3/4"	2"
PS-520	5/8" & 3/4"	3"

Cone Auger



PART NUMBER	CABLE	LENGTH	CONNECTOR SIZE
PS-855	1/2" & 7/8"	6"	7/8"
PS-010	3/8" & 1/2"	3"	5/8"

Spiral Cutter



PART NUMBER	CABLE	PIPE SIZE	CONNECTOR SIZE
PS-025	3/8" & 1/2"	2"	5/8"

Boring Auger



PART NUMBER	CABLE	PIPE SIZE	CONNECTOR SIZE
PS-000	3/8" & 1/2"	7/8"	5/8"
PS-995	3/8" & 1/2"	1-1/8"	5/8"

Heavy Duty C-Grease Cutter



PART NUMBER	CABLE	SIZE	CONNECTOR SIZE
PS-812	3/8" & 1/2"	2"	5/8"

Drop Head Auger



PART NUMBER	CABLE
PS-065	3/8" & 1/2"

Pin Key

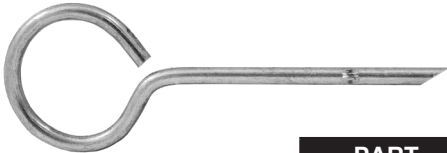

PART NUMBER	CABLE
PS-A13	3/8" & 5/8"

U-Grease Cutter



PART NUMBER	CABLE	SIZE	CONNECTOR SIZE
PS-837	3/8" & 1/2"	1"	5/8"
PS-005	3/8" & 1/2"	1-3/8"	5/8"



Generic Ridgid Style

PASCO manufactures these Drain Snake Specialties to the exacting standards of the professional plumbing industry. The products pictured on the following pages fit a variety of drain snake cables used in the plumbing trade.

Arrowhead Grease Cutter



PART NUMBER	CABLE	SIZE	CONNECTOR SIZE
PS-030	3/8" & 1/2"	1"	5/8"
PS-035	3/8" & 1/2"	1-3/8"	5/8"
PS-040	3/8" & 1/2"	1-3/4"	5/8"

Arrowhead



PART NUMBER	CABLE	SIZE
PS-495	5/8" & 3/4"	1-3/4"

Spearhead Grease Cutter



PART NUMBER	CABLE	SIZE	CONNECTOR SIZE
PS-870	1/2"	2-1/2"	7/8"

Knife U-Cutter



PART NUMBER	CABLE	SIZE	CONNECTOR SIZE
PS-842	1/2"	1-1/2"	5/8"
PS-852	1/2"	2-1/2"	5/8"

Quad Cutter



PART NUMBER	CABLE	SIZE	CONNECTOR SIZE
PS-045	3/8" & 1/2"	1"	5/8"
PS-050	3/8" & 1/2"	1-3/8"	5/8"

6 Piece Toolset - 3/8" Cable

For 3/8" Cable

Contains one each:

- 1-1/8" Boring Auger (PS-995)
- 1" U- Grease Cutter (PS-837)
- 1" Arrowhead Grease Cutter (PS-030)
- 1-3/8" U-Grease Cutter (PS-005)
- 1-3/8" Arrowhead Grease Cutter (PS-035)
- Pin Key (PS-A13)

PART NUMBER
PS-240



Quad Cutter



PART NUMBER	CABLE	SIZE	CONNECTOR SIZE
PS-930	1/2"	1-3/4"	7/8"

Arrowhead Cutter



PART NUMBER	CABLE	SIZE	CONNECTOR SIZE
PS-880	1/2"	1-3/4"	7/8"



Professional Auger Set

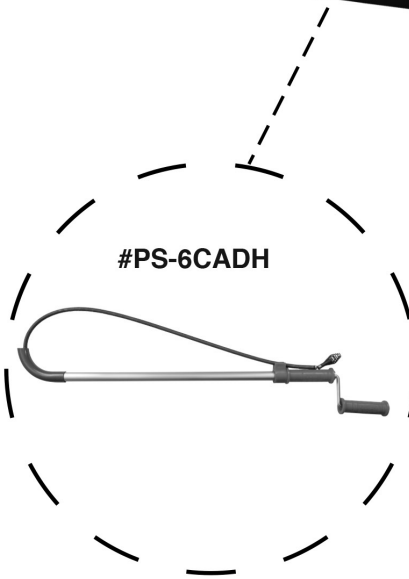

- 6' Telescoping cable
- 1-1/8" Heavy duty guide tube
- Large handle for easy grip and better feel
- Drop head cable end



- Keeps water and waste from dripping on the floor while exiting jobs
- Inside pockets for essential items, handles, and shoulder strap for easy carry
- Holds two augers
- Air holes to help dry

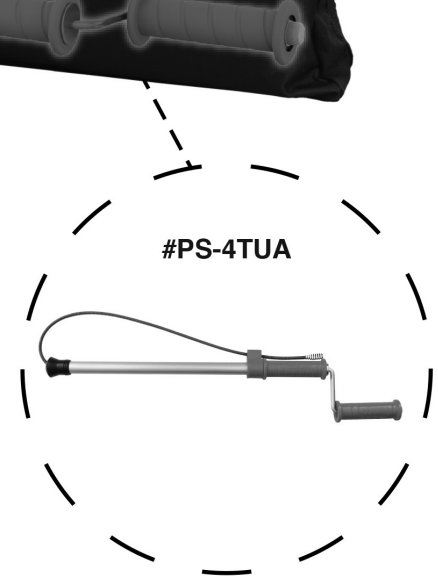

- 4' Telescoping cable
- 1-1/8" Heavy duty guide tube
- Large handle for easy grip and better feel
- Drop head cable end

PART NUMBER	DESCRIPTION
ProAugSet	3- Piece Professional Auger Set
PS-BAG	Auger Bag Only

Closet & Urinal Augers

Regular Head

- Professional plumber style
- Cable hold clip molded on handle
- Tempered spring steel
- Vinyl grips and bowl guard

6' model has telescoping cable feature:
press button on shaft and pull cable out

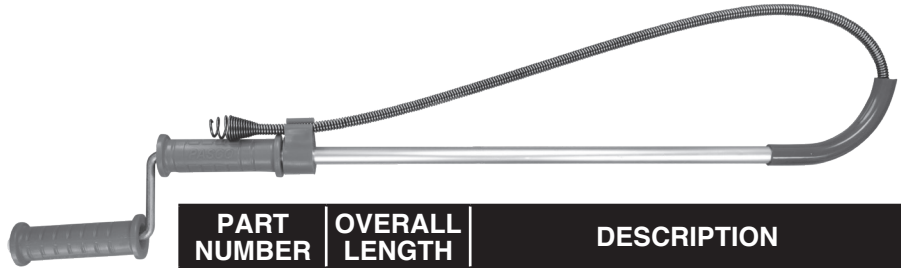
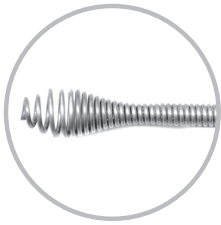

PART NUMBER	OVERALL LENGTH	DESCRIPTION
PS-3CA	3'	1-1/8" Heavy Duty Guide Tube
PS-6CA	6'	

Drop Head

- Professional plumber style
- Cable hold clip molded on handle
- Tempered spring steel
- Vinyl grips and bowl guard

6' model has telescoping cable feature:
press button on shaft and pull cable out



PART NUMBER	OVERALL LENGTH	DESCRIPTION
PS-3CADH	3'	1-1/8" Heavy Duty Guide Tube
PS-6CADH	6'	

Urinal - Regular Head

- Professional plumber style
- Cable hold clip molded on handle
- Tempered spring steel
- Vinyl grips and bowl guard

4' Telescoping Cable

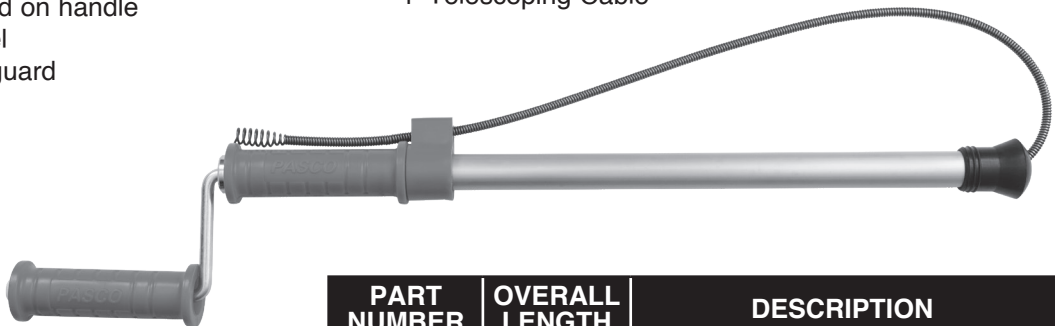

PART NUMBER	OVERALL LENGTH	DESCRIPTION
PS-4TUA	4'	1-1/8" Heavy Duty Guide Tube



Utility Pump

- Corrosion proof
- Provides quick removal of water
- Self-priming, lightweight utility pump
- High strength, ergonomic handle can withstand extreme temperatures and harsh usage
- 36" pump provides quick removal of 1 gallon in 4 strokes
- 24" extension available; fits to existing pump to access hard to reach areas
- Steel shaft improves strength
- Flexible discharge hose for directing water evacuation
- Removable intake foot for easy cleaning
- Perfect for removing water from valve boxes, meter pits, pipe trenches, and anywhere water accumulates
- Use to drain or transfer water
- Large volume of water drawn with each pull of the handle

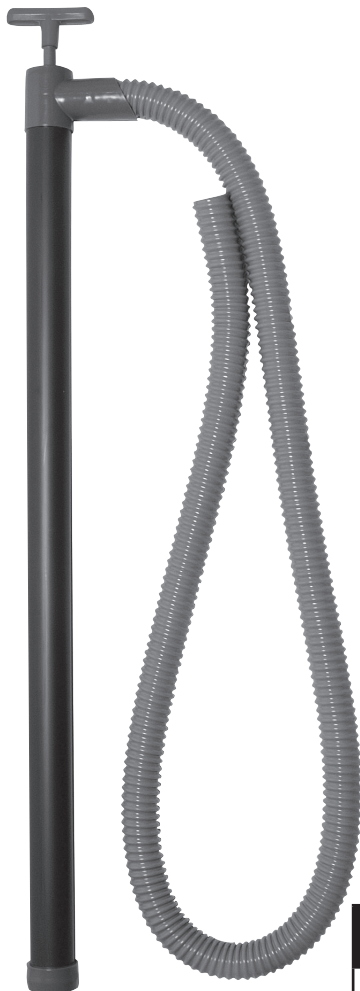

PART NUMBER	HOSE LENGTH
136PF-6	6 ft.

Eureka Cleanout Plug Wrench

- This unique tool fits either slotted or square countersunk cleanout plugs
- Strong, malleable iron
- Fits slotted or square

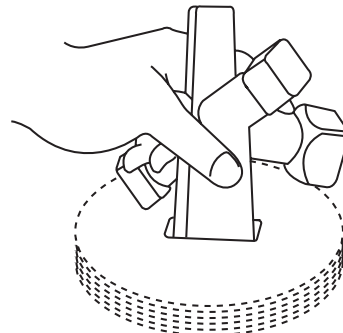
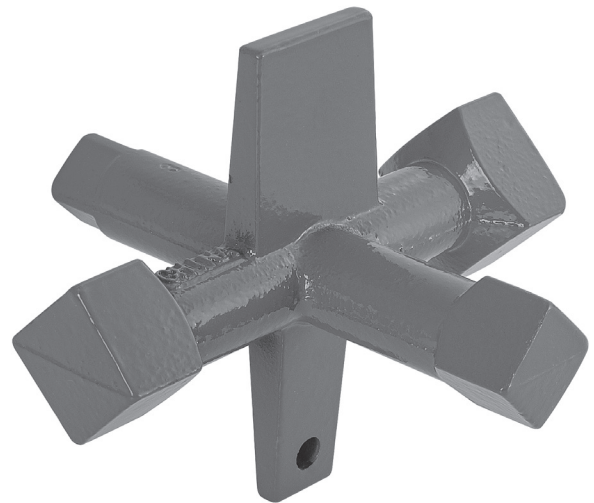

PART NUMBER
4567



The Original Pumie® Scouring Stick

- Cleans where chemicals fail
- Removes stubborn lime, rust and drain snake marks from porcelain & ceramic
- Plastic handle style for hard to reach spots



PART NUMBER	HANDLE	DISPLAY PACK
3125	NO	12
3126	YES	6

Atlas® Fit 300 - Blue

The original palm coated glove!

- Natural rubber coating
- Breathable back
- Seamless knit liner
- Outstanding grip
- Ergonomic fit
- Packed 12 pair



PART NUMBER
300M
300L
300XL

Drain Snake Glove

Preferred by Plumbers

- PVC/NBR blend coating with PVC chips for non slip
- Chemical Resistant
- Cuffed wrist



PART NUMBER	PACK QTY
GL4100	1

Atlas® Nitrile Tough Gloves - Black

Long cuff & dark grey coating

- Grips
- Won't slip when wet
- Durable
- Resists solvent cement
- Packed 12 pair



PART NUMBER
370M
370L
370XL

Drain Snake Glove

Preferred by Plumbers

- PVC/NBR blend coating with PVC chips for non slip
- Chemical Resistant
- Mid-forearm length



PART NUMBER	PACK QTY
GL4112	1

Atlas® Nitrile 380 - Blue/Black

Waffle Pattern Palm

- Lint free nylon liner
- Compressed air-infused foam nitrile coating
- Waffle pattern provides good grip in wet conditions
- Heavy duty
- Packed 12 pair



PART NUMBER
380M
380L
380XL